

SPECIFICATIONS:

- BTUH = 108,000
- FUEL = NG@ 5 W.C. OR LP @ 10 W.C.
- ELECTRICAL POWER = 115 VAC / 1.44 A / 60 Hz.
- GAS CONNECTION = 1/2" NPT (NG) OR 3/8" ODF (LP)
- CART BODY MAY BE PLACED TO NO LESS THAN 3" FROM NON-COMBUSTIBLE MATERIALS

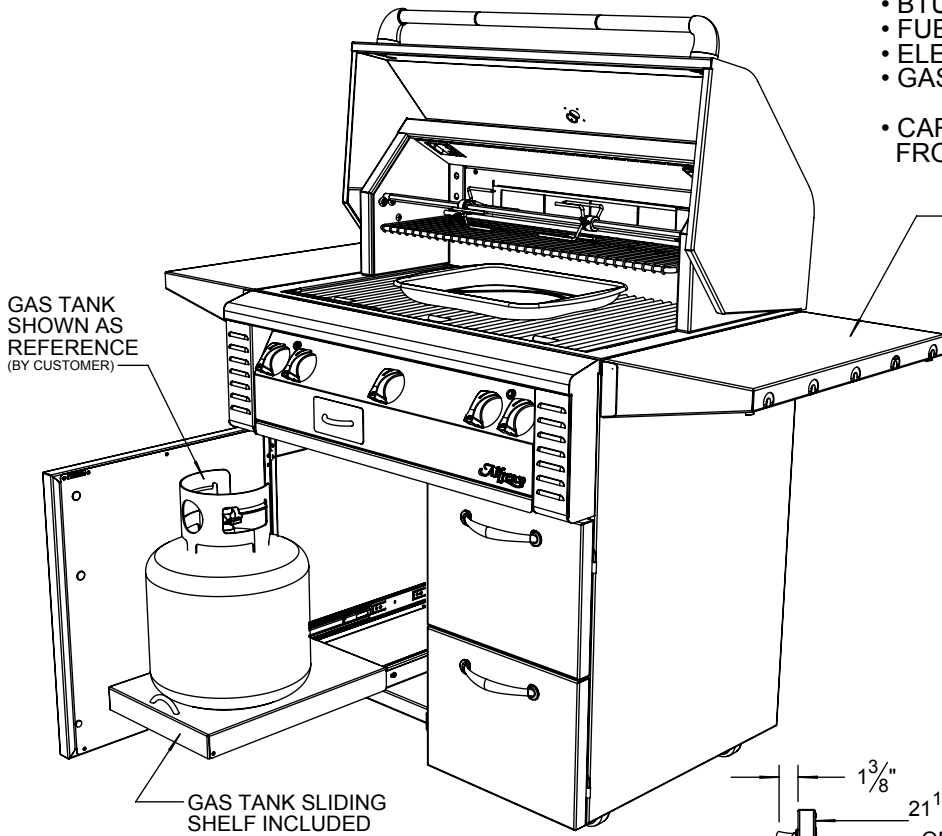

ALX2-36SZ SHOWN ON AL-36CD DELUXE CART

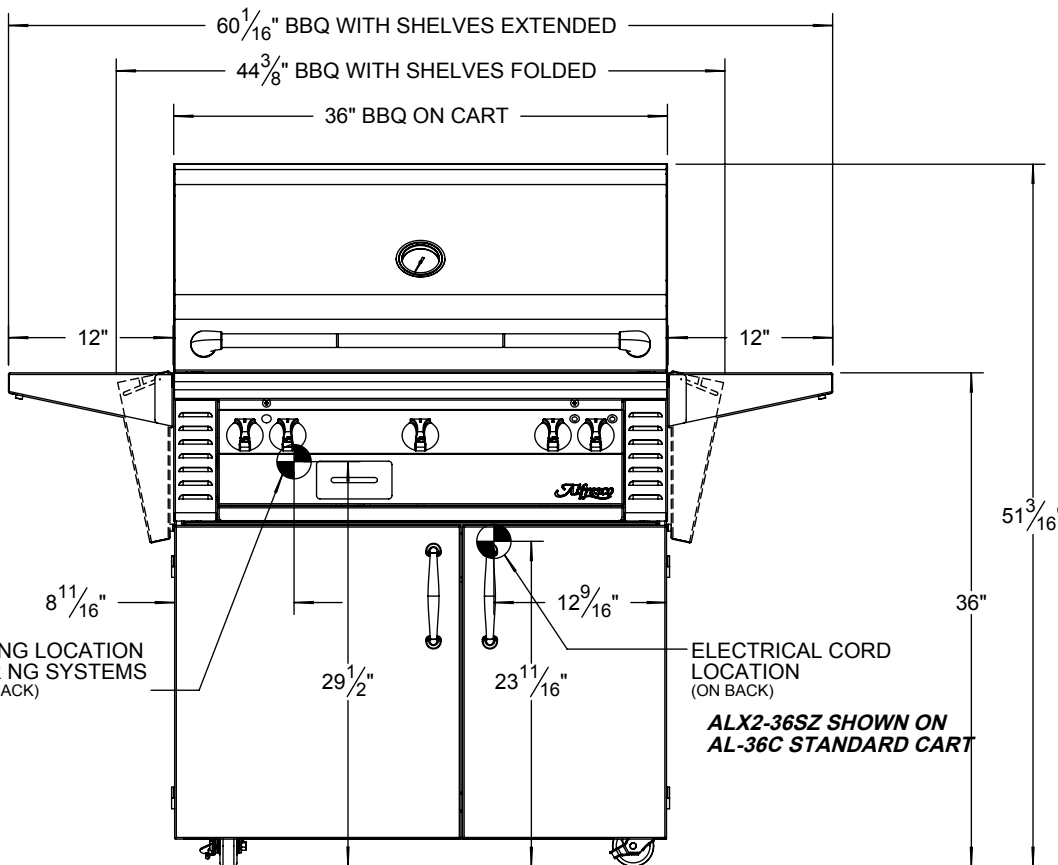
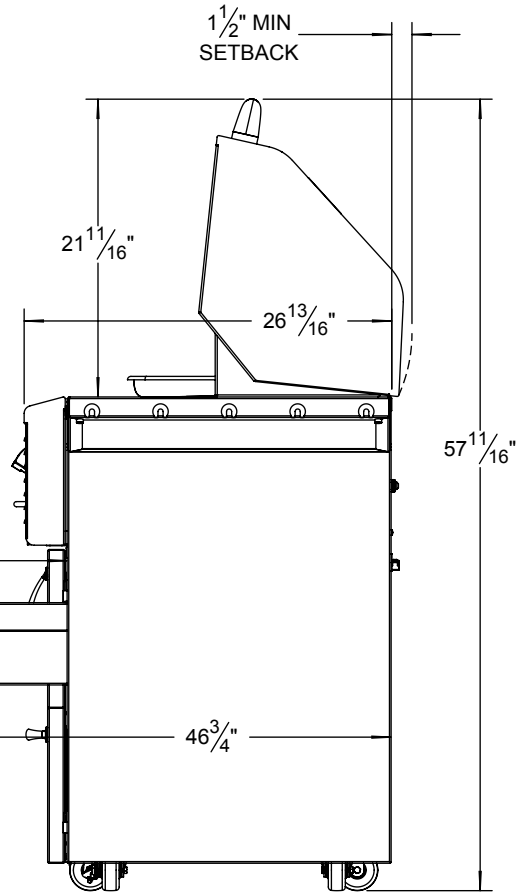

ALX2-36SZ SHOWN ON AL-36C STANDARD CART